

# POWER

for your production

**Espaso**<sup>®</sup>

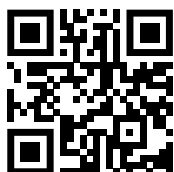

[www.espaso.com](http://www.espaso.com)



**Neubauer**  
Automation

### SO MANY POSSIBILITIES

You can adapt your ESPASO exactly to your needs and configure it freely according to your wishes.

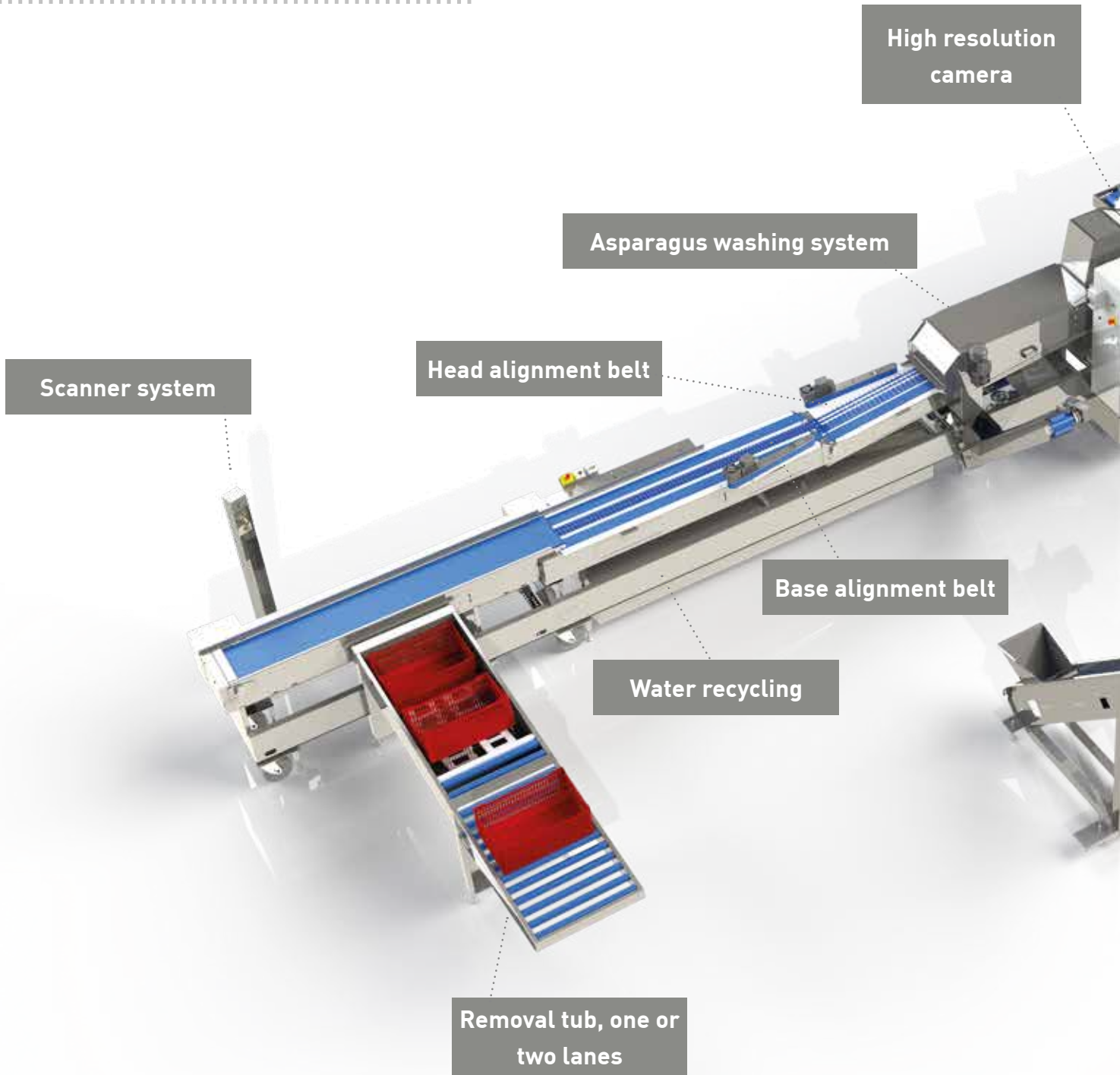

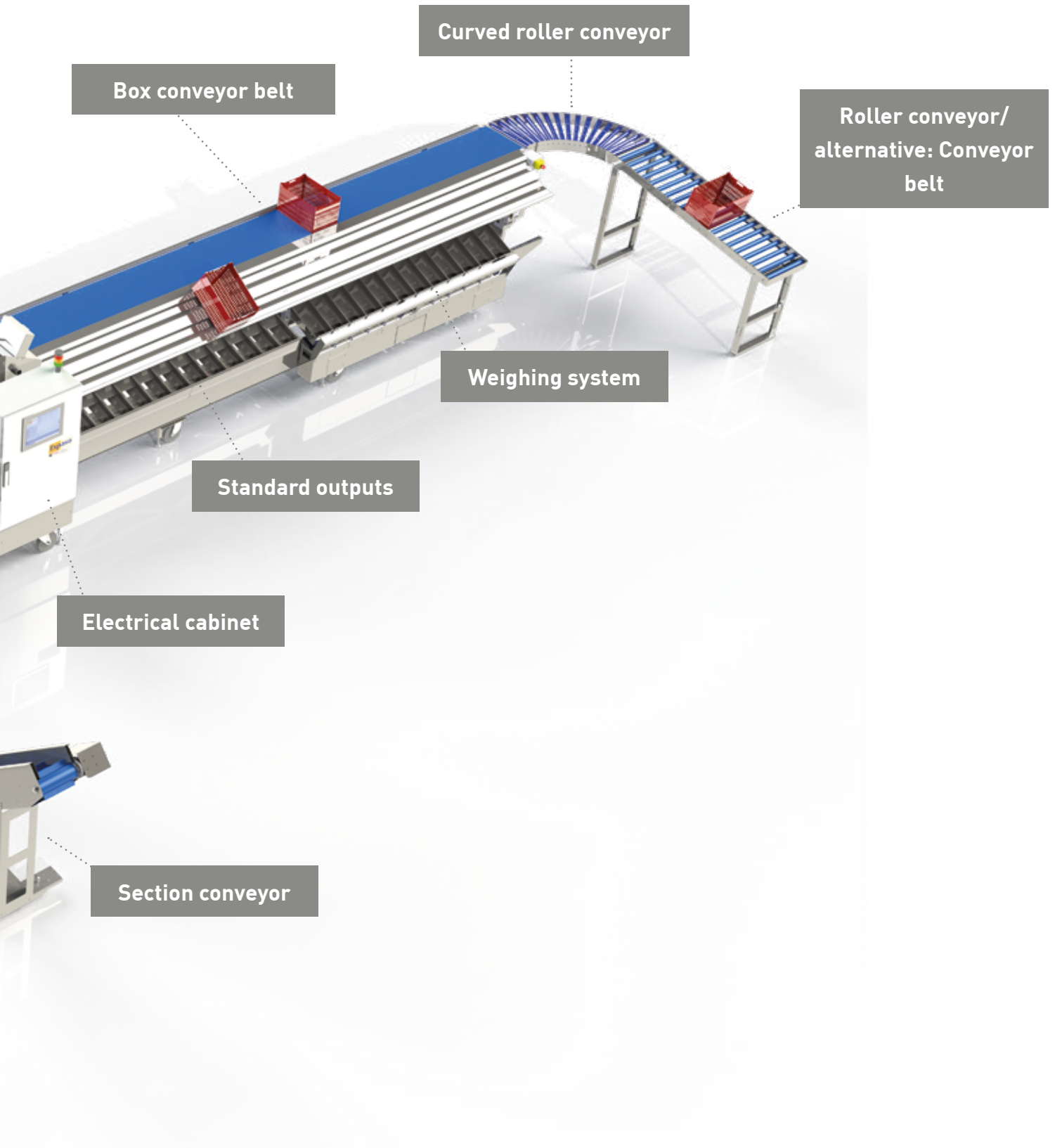

Curved roller conveyor

Box conveyor belt

Roller conveyor/  
alternative: Conveyor  
belt

Weighing system

Standard outputs

Electrical cabinet

Section conveyor

## SO MANY ADVANTAGES

The ESPASO combines functionality, innovation and vision into a perfect product and offers numerous features to optimize your asparagus sorting.



### Software/ Remote service

Our own intuitive software running on Linux, has been maintained since 1999 and constantly adapted to your needs. It´s easy to use. The program is connected to our server with a VPN-based remote maintenance, which ensures quick help.



### Camera

The ESPASO has a high-resolution, long-life industrial camera for the best sorting results.



### Husks-Nozzle system

The sensible arrangement of additional husk nozzles ensures reliable removal of the asparagus husks.



### Cleaning system

A powerful cleaning system with a combination of nozzles from above and brushes from below guarantees reliable cleaning of each asparagus spear. Due to the technical division of the toothed belt, the asparagus can move and rotate freely in the cleaning section.



## Motors

---

High quality motors from SEW (made in Germany) with reinforced corrosion protection guarantee a long service life.

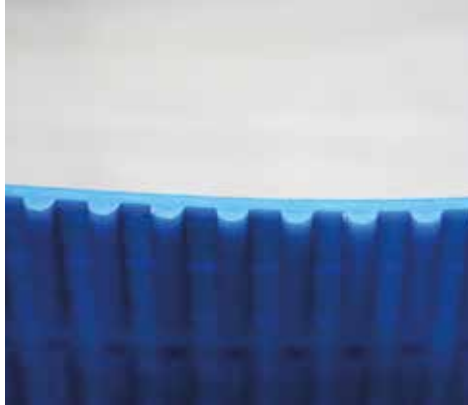

## Proven Toothed Belt Technique

---

All of the ESPASO's toothed belts are Kevlar-reinforced and run on water lubrication, oil free and do not stretch.



## Transport swivel castors

---

Strong transport swivel castors with adjustable feet ensure the necessary mobility to freely position your machine.



## Schaumfee

---

A clean lime, mold and germ-free machine is important for your process. The ESPASO is designed in such a way that it can be cleaned and disinfected daily with foam cleaning systems such as the "Schaumfee".

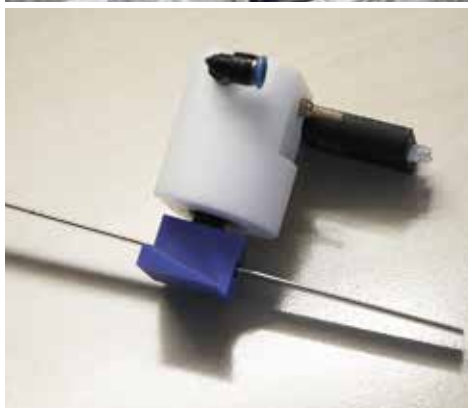

## Cylinder

---

Easily accessible cylinder unit. Low maintenance and timesaving to replace.

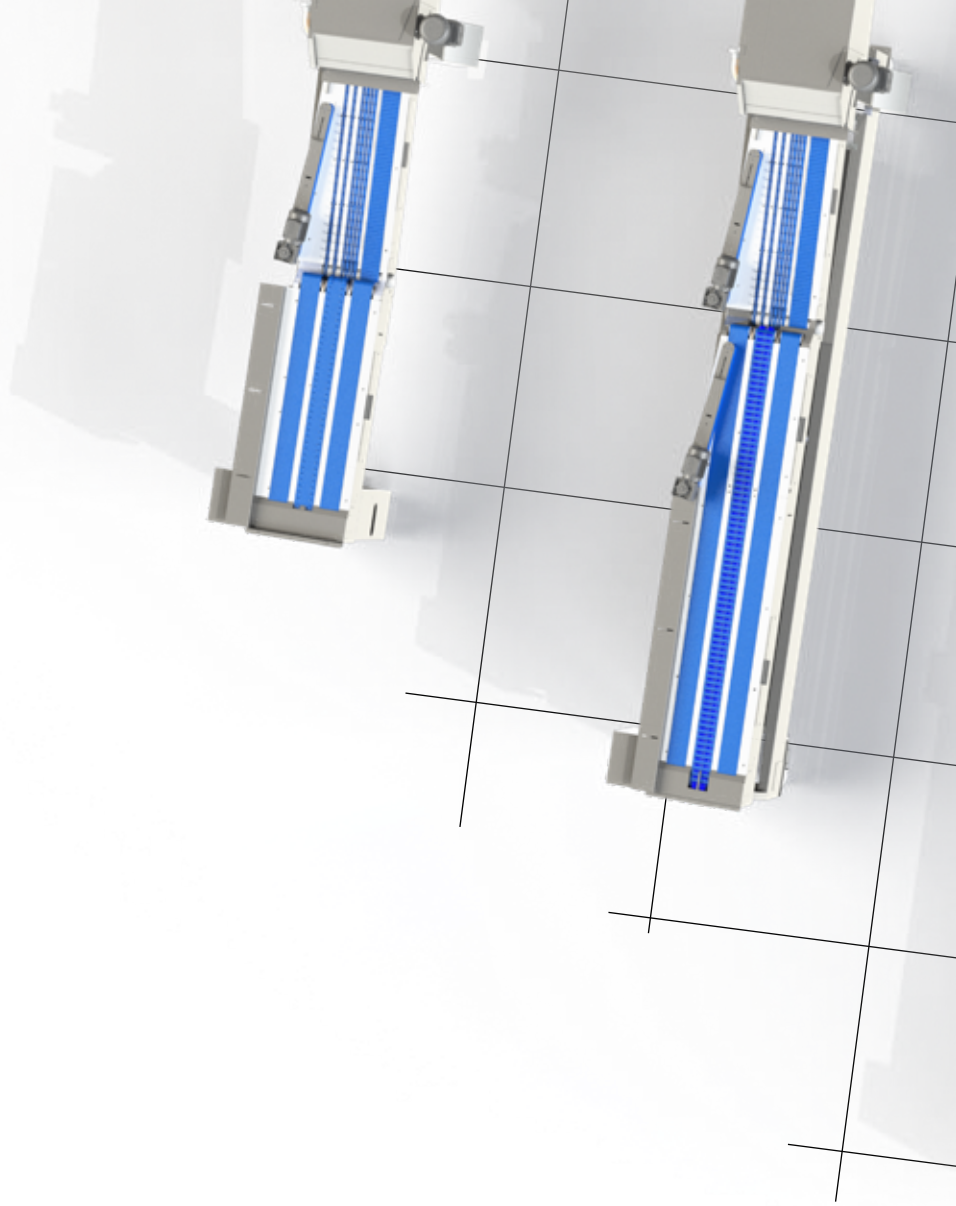

## **Infeed section options?** **Total flexibility!**

Every ESPASO is designed for maximum sorting performance. Optimized work processes, intelligent features such as the turbocharger, water jet cutting or integrated weighing make every ESPASO a high-performance system for sorting green and white asparagus.

Whether it is a short turbocharger, flat belts in various lengths, or even a second cutting / washing unit, the ESPASO adapts to your efficiency requirements and the available space.

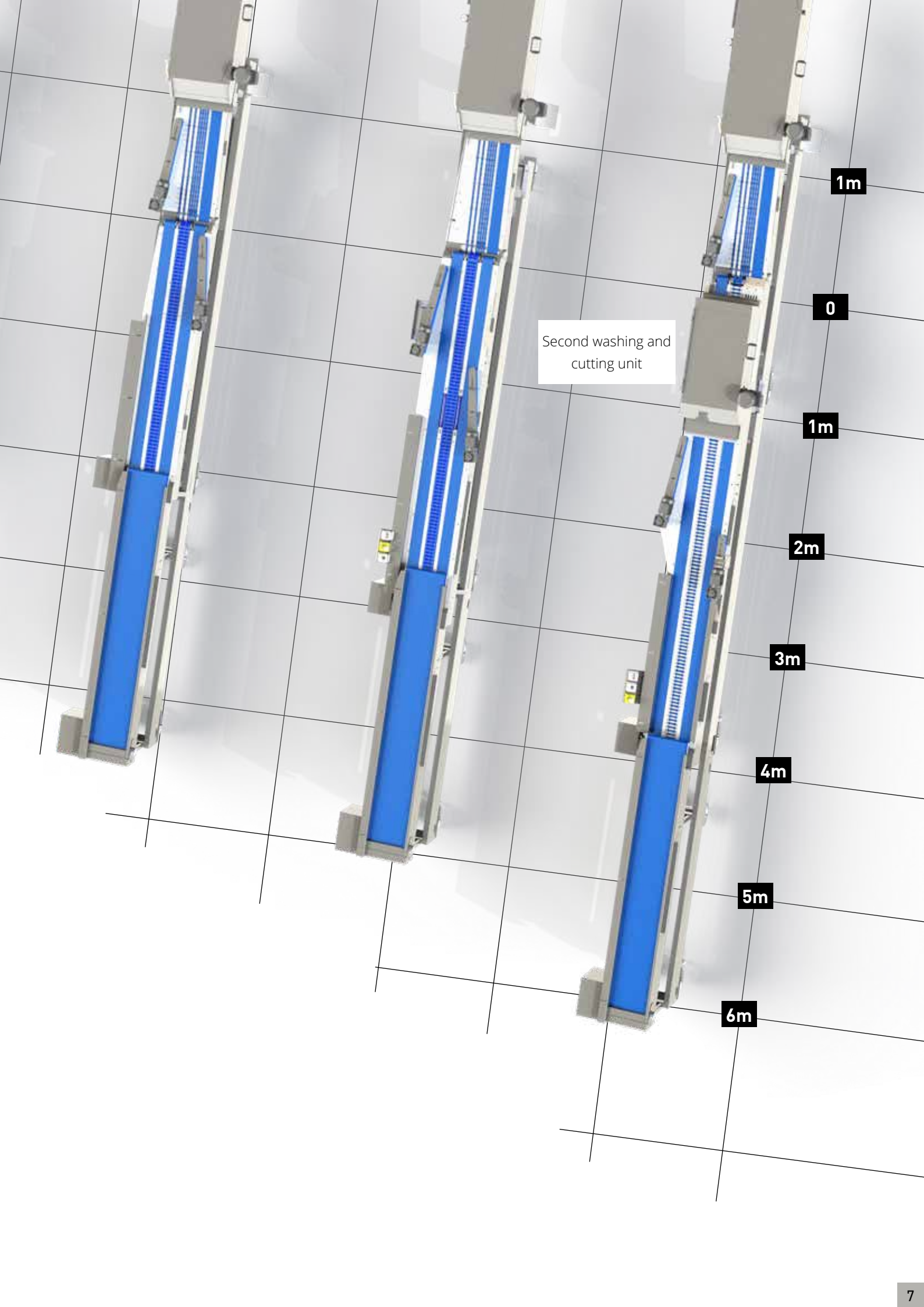

Second washing and cutting unit

1m

0

1m

2m

3m

4m

5m

6m

# White, green and purple asparagus perfectly sorted

Whether you use an ESPASO on a two-hectare farm or on a large enterprise with several hundred or thousand hectares – you will see how fast and economic your sorting will become.

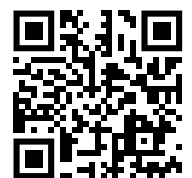

Video



# Good reasons for choosing an ESPASO



## Reduce costs

The ESPASO automatic asparagus grading machine can cut sorting times in half, reduces personnel and reduce significantly your wages and operating costs.



## Increase productivity

Optimized work processes and intelligent features such as the turbocharger or integrated weighing will double the amount of sorted asparagus and maximize the operating result.

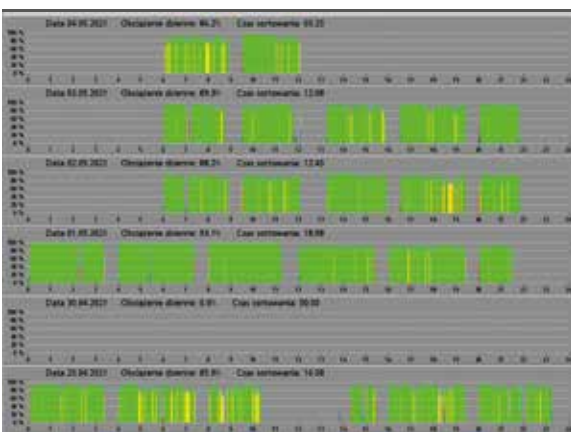

## Optimize utilization

The ESPASO achieves a consistently high utilization of over 90% and, under ideal conditions, is able to sort up to 2 tons of asparagus per hour - depending on the average weight of the asparagus.



## Perfect the sorting quality

The well thought-out measuring and weighing process delivers perfect bundles of asparagus of the same length, weight and diameter and the same head quality. In a nutshell: a nice bundle.

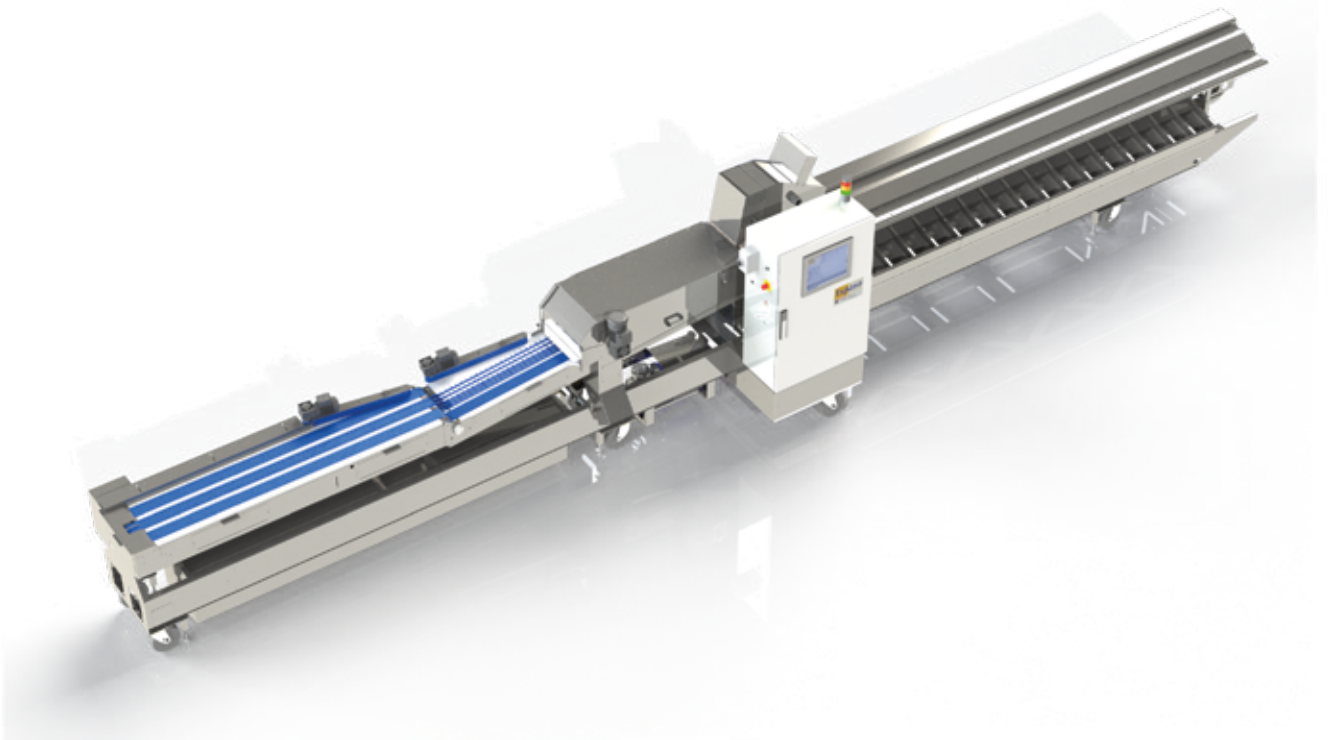

## The asparagus sorting machine with **one-sided asparagus tray**

The ESPASO with one-sided asparagus tray is user-friendly designed. Well thought-out control elements and ways, high quality materials and years of development experience make the ESPASO the best-selling asparagus sorting machine in the world.

### Facts

It sorts green and white asparagus efficiently and accurately

Outputs on one side of the machine

Right machine and left machine available

The world's best-selling asparagus sorting machine with over 950 machines running.

Model	Sorting speed (in spears per hour)	Sorting outputs design	Length (in m)	Width (wet/dry) in m	Number of sorting outputs	Weight (in Kg) without accessories.
S12e	18.000 - 36.000	wet / dry	7,80	1,15 m / 0,80	12	850
S16e	18.000 - 36.000	wet / dry	9,70	1,15 m / 0,80	16	1.000
S20e	18.000 - 36.000	wet / dry	10,54	1,15 m / 0,80	20	1.150
S24e	18.000 - 36.000	wet / dry	11,38	1,15 m / 0,80	24	1.300
S28e	18.000 - 45.000	wet / dry	12,22	1,15 m / 0,80	28	1.500
S32e	18.000 - 45.000	wet / dry	13,06	1,15 m / 0,80	32	1.700
S36e	18.000 - 45.000	wet / dry	13,90	1,15 m / 0,80	36	1.900
S42e	18.000 - 45.000	wet / dry	14,74	1,15 m / 0,80	42	2.100
S48e	18.000 - 45.000	wet / dry	15,58	1,15 m / 0,80	48	2.300
S56e	18.000 - 45.000	wet / dry	17,10	1,15 m / 0,80	56	2.500
S60e	18.000 - 45.000	wet / dry	17,94	1,15 m / 0,80	60	2.700

The length varies depending on the feeding system.



## The asparagus sorting machine with **two-sided asparagus tray**

Ideal when there is little space. The asparagus outputs are arranged on both sides of the asparagus sorting machine. This ensures high sorting performance with compact dimensions, so that the ESPASO can be operated in the smallest spaces.

### Facts

It sorts green and white asparagus efficiently and accurately

Outputs on both sides of the machine

Right machine and left machine available

Model	Sorting speed (in spears per hour)	Sorting outputs design	Length (in m)	Width (wet) in m	Number of sorting outputs	Weight (in Kg) without accessories.
S12	16.000	wet	6,60	1,70	12	650
S16	18.000 - 36.000	wet	8,00	1,70	16	720
S20	18.000 - 36.000	wet	8,42	1,70	20	790
S24	18.000 - 36.000	wet	8,84	1,70	24	850
S28	18.000 - 45.000	wet	9,26	1,70	28	930
S32	18.000 - 45.000	wet	9,68	1,70	32	1.000
S40	18.000 - 45.000	wet	10,01	1,70	40	1.200
S48	18.000 - 45.000	wet	10,52	1,70	48	1.400
S56	18.000 - 45.000	wet	10,94	1,70	56	1.700
S60	18.000 - 45.000	wet	11,36	1,70	60	2.000

The length may vary depending on the feeding system.



# Perfect sorting with LED-light



## DATA EVALUATION

Each ESPASO is equipped with a special software developed by ourselves. It is spacious, proven and easy to use.

This is so that you can concentrate on your asparagus process and not on studying complex software processes.

Simple Operation, menu navigation by touchscreen, sophisticated diagnostic software, networking capability.

Evaluation of the harvest quantities

Open interface to commercially available accounting programs or customer software.

The code is entered without delay while sorting is in progress using a barcode scanner (as an option).

Remote maintenance and error analysis via the integrated internet connection.

Change of sorting parameters at running machine via Internet

## THE MEASURING PRINCIPLE

The asparagus rolls down on a short measuring surface and is photographed 5 to 12 times from all sides. This means that every point on the asparagus spear is recorded precisely. The measurement is so precise that the individual weight of each asparagus spear is also determined with a tolerance of  $\pm 3\%$ .

The asparagus is measured on a steady, non-moving background. This guarantees professional and high-precision sorting. Changing the sorting parameters it is possible while the machine is running via the Internet.

# This is how the ESPASO® works



## ASPARAGUS OUTPUTS

In addition to quality, flexibility is another strength of the ESPASO. This continues in the choice of asparagus outputs. Whether water or dry outputs, whether one-sided or two-sided. When it comes to removing asparagus, **Neubauer Automation focuses on the most important of your wishes and ideas.**



## RECOGNIZES HOLLOW SPEARS

An additional camera (optional) improves recognition of hollow white asparagus spears. As a result of the different early harvesting methods, at the beginning of the season in many companies there are periods in which there is a significantly high proportion of hollow asparagus spears.

In some cases, this is more than 40% of the harvested quantity. With its existing software, Neubauer Automation separated the hollow spears according to the following characteristics: double spears, ovality and club-shaped.



However, the straight but hollow spears were not recognized in this way. The ESPASO is able to reliably recognize straight hollow spears during the sorting process and to sort them out efficiently. An additional camera, which focuses on the foot of the spear, recognizes the hollow spears, which have a visible opening at the foot end, and reliably sorts them out.

## SORTING FEATURES

The ESPASO software reevaluates white and green asparagus different characteristics. In this way, the spears can be sorted exactly according to your specifications.

- Length .....
- Thickness .....
- Thickness difference .....
- Curvature, S-curvature .....
- Head curvature .....
- Violet color, green color, rust .....
- Blossom in white asparagus .....
- Open tips in green asparagus .....
- Rotten spots .....
- Ovality .....
- Double spears .....
- Grooves .....
- White bottom .....
- Branches .....



## WASH & CUT

A newly designed cleaning system washes the asparagus of all sides. Rotating lower brushes turn each spear. Powerful water jets hit the asparagus and clean it optimally. Fresh water nozzles do the final cleaning.

# Sorts perfect bundles of green asparagus with spears of the same length

Well thought-out technology and high-quality manufacturing create a machine that will **optimize your production and maximize your incomes**. The asparagus is cut with a water jet, which enables the selective cutting of each individual asparagus spear to a specified length.

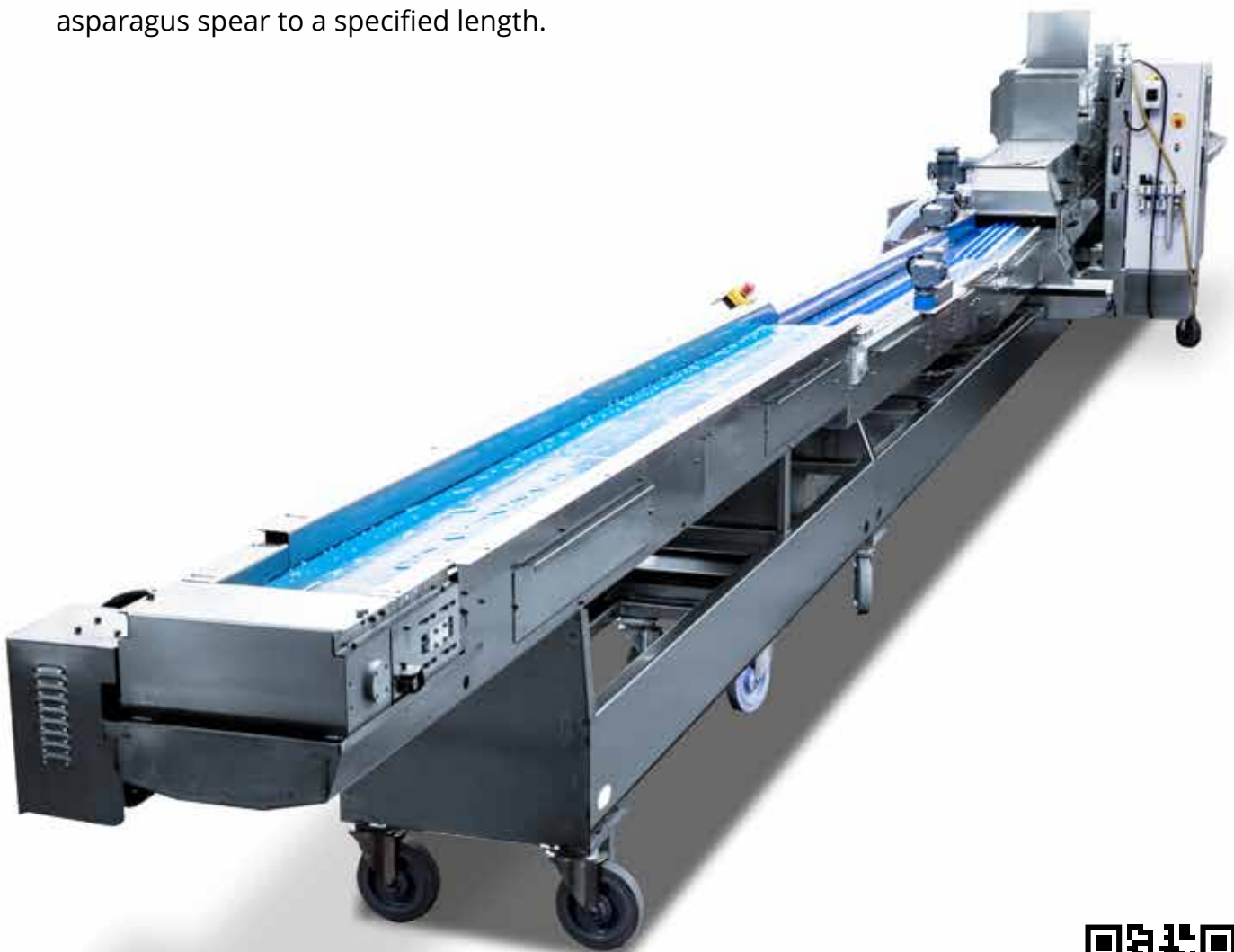

Video

# Why should you use an **ESPASO SEC** for green asparagus?



## **Perfect asparagus bundles**

The intelligent selective cutting system, combined with selection of the stretched length, makes it possible to cut every asparagus spear - straight or curved - to a precisely defined length. This is how to create bundles with asparagus spears of exactly the same length.



## **Minimize asparagus cutting waste**

Flexible water jets can position every cut as required and cut every single spear individually. No need for later manual cutting. Allows exact cut-off at the edge of the field cut and thus **minimizes waste by up to 12%**.

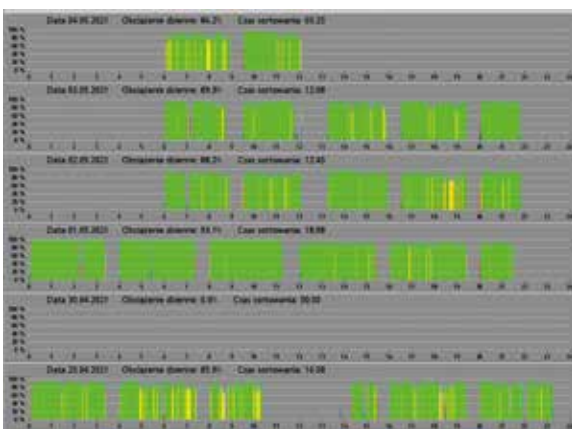

## **Optimize Performance**

The ESPASO SEC achieves a consistently high level of performance of over 90% and is under ideal conditions capable to grade up to 2 Tons asparagus per hour, depending on the average weight of the asparagus.



## **Cut white feet**

The software's intelligent asparagus evaluation differentiates exactly where the transition between the green spears and the white bottom is and enables the exact section of white feet.



# That's the ESPASO<sup>®</sup> SEC

The ESPASO Sec is an **automatic asparagus sorting machine with an integrated water jet cutting robot and an asparagus weighing unit.**

This unique combination enables the production of optimized asparagus bunches.

Short asparagus, tips, rotten spots, curved or curved asparagus, cut to length depending on the variety or whether you want to make bundles of asparagus with exactly the same length, the Neubauer water jet cutting, enables exact cuts without any subsequent adjustments in a single process.

## ✓ FACTS

Produces optimal bunches by the unique combination of selective cutting and

weighing unit

Selective cut according to the stretched length

Optimal use of the asparagus length

Cutting according to parameters such as white bottom, Thickness or quality

Multifunction tray to make the bundles

Available as a left and right machine

Model	Sorting speed (in spears per minute)	Sorting outputs version	Length (in m)	Width (in m)	Number of sorting outputs
S48	18.000 - 45.000	dry	24,5	2,3	48
S60	18.000 - 45.000	dry	27,0	2,3	60

The length varies depending on the feeding system.





# This is how the ESPASO SEC<sup>®</sup> works

## DATA EVALUATION

Every ESPASO will be provided with our special software that we have developed ourselves. It is extensive, sophisticated and easy to use, so that you can concentrate on your asparagus harvest and not on studying complex software processes.

- Easy operation, touch screen menu navigation
- Sophisticated diagnostic software
- Network-compatible

- Open interface to standard commercial accounting programs or customer's own software
- Code-entering takes place without time delay during on-going sorting via barcode scanner.
- Remote service and error analysis via integrated internet connection
- Changes to sorting parameters while machine is operating via the internet



## SORTING CHARACTERISTICS

The ESPASO software evaluates green asparagus according to various characteristics. In this way, the asparagus spears can be sorted exactly according to your specifications.

- Length
- Stretched length
- Curvature
- S-curvature
- Head curvature
- White bottom (on green asparagus)
- Blossom



## THE ASPARAGUS OUTPUTS

Ergonomically arranged dry asparagus storage tanks made of stainless steel ensure uncomplicated asparagus removal.



## WASH & CUT

The cleaning system washes all sides of the asparagus. Rotating under-brushes turn the individual spears. Powerful jets of water give optimal washing results. Fresh water jets complete final cleaning.



## Accessories for the asparagus sorting machine

Our comprehensive range of accessories optimizes your production processes and sequences. For internal transport using roller conveyors, or for direct weighing and packing of the asparagus, Neubauer Automation offers you well-designed solutions for asparagus sorting.



### **WEIGHING UNIT FOR ASPARAGUS**

The quality and weight of each spear are determined by a measuring camera and individual asparagus are then combined to make bundles of a previously determined weight into the outputs.

Each asparagus output is equipped with scales which constantly check the total weight of the bunch

No bunches which are too light or heavy (the whole bunch is weighed).

Inclusion of different qualities of asparagus according to your specifications.

Real-time weight monitoring: The total weight of the bunches is checked, so spears (broken or unattractive) can be removed from the outputs. The weighing unit automatically refills the gaps until the target is reached.



## REMOVAL TUB, 1 AND 2 LANES

Easier asparagus removal from the field boxes; faster laying on the sorting machine

Stainless steel tub for boxes up to 60 x 40 cm

Two intake rollers combined with a 1.2 m long conveyor roller or two 1.2 m long conveyor by a two lanes tub.

With water level regulation and height-adjustable stainless steel feet

Overall length: 2.88 m



## SCANNER

Harvest quantity recording for asparagus harvesters and fields

Code recording takes place without delay during sorting



## BOX SHELF

Multi-functional shelf for maximum flexibility, simplifies handling of the bunches and boxes.



## STAINLESS STEEL ROUND TABLE

Automatic buffer storage for asparagus to use behind an asparagus bundling machine

Diameter: 148 cm

Rotation speed: 2.3 rotations per minute

Height: 77 - 89 cm

Load capacity: 50 kg



## CUT-OFF CONVEYOR

Cut-off conveyors dispose of your asparagus residues in large containers or according to your requirements, system-orientated and individually according to customer requirements.

Also available: Ascending conveyor up to 6.50 m length, and horizontal conveyor up to 20 m length.



## BUNDLING AID FOR ASPARAGUS

Simplifies and speeds up manual bundling: Place the bundle of asparagus in the cup and pull rubber over

Stainless steel cup, high-quality, stainless and durable

Easy to set up anywhere



## ROLLER CONVEYORS AND ROLLER CONVEYOR WITH SCALES

Roller conveyors optimize the flow of goods, saving time, costs and space.

The integrated scales and the flexible, easy-to-handle roller conveyors provide a logistical all-round solution. Load capacity: 50 kg



## ASPARAGUS BUNDLING MACHINE

Fast, efficient bundling with the ASPAPACK automatic bundling machine

Bunch sizes adjustable to your requirements

Asparagus transport without binding stop

Two binder tie the bunches using elastic yarn



## STAINLESS STEEL PACKING TABLE

With shelf for asparagus boxes

Integrated scales

Foil holder

Height-adjustable feet

Height-adjustable lower shelf

Width 2 m, depth 1 m, table height adjustable



## BOX CONVEYOR

Transports your finished product from the machine to the cold storage house or the removal point.

Standard widths: 42 cm, 52 cm, 62 cm or acc. to customer's individual wishes.

# Schaumfee



Effective **cleaning and disinfecting** easily done!  
Simply hygienic!



## Technical specifications

Maximum operating pressure 8 bar,  
Compressed air 200 l / min (6 bar),  
Connection of compressed air plug  
nipple NW 7.2, Connecting water  
Geka coupling

Height about 1,100 mm

Width about 520 mm

Depth about 300 mm

Weight approx. 48.5 kg

Water pressure min 3 bar  
max. 6 bar

## Equipment

1 piece foam lance

10 m supply air line PVC clear  
braided hose

15 m supply PVC braided hose

The Schaumfee reliably creates a dense and well-adhering foam that thoroughly cleans and disinfects machinery and areas.

For this purpose, 2 types of cleaning agents are used:

## Mild alkaline disinfectant cleaner for daily cleaning.

- Cleans and disinfects
- Bactericidal and fungicidal
- Gentle on skin and material

## Citron-sour foam cleaner for weekly cleaning

- Solves pigment dirt and inorganic deposits
- Removes grease spills
- Eliminates oxidizing and tarnishing colors  
(Details see Data sheet)

After 5-15 minutes of exposure time, rinse with clear water.  
The cleaners are fully biodegradable.

# Accurate weighing saves weight, increases your profit and protects against complaints.

Our tried-and-tested turbocharger technology feeds the asparagus to the weighing line. A cutting unit is positioned upstream of this and can be used as an option if the asparagus is to be given a fresh cut edge.

The filled trays are guided over a continuous weighing system, whereby the weight of each tray is registered three times and a reliable average value is calculated from this.

The filled trays are then placed on 8 belt scales. The computer now knows both weights and fills the belt scales with the remaining quantity until the target weight with the pre-set tolerances is reached.

The asparagus is then transported into the removal tray and can then be manually transferred to a flow pack or bundling system.

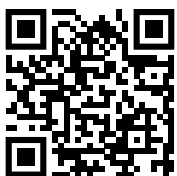

Video



## FACTS

The triple weighing of the filled weighing trays and the intelligent communication with the belt scales at the end of the measurement chain achieve close tolerance for the asparagus bunch.

The construction's rigid and solid design protects against external influences such as vibration etc.

The machine's performance is considerably increased by the possibility of multiple occupancy of a weighing tray and the 8 outputs

Thanks to our tried-and-tested toothed belt technology, the machine operates completely without oil, grease and water.



## TECHNICAL DATA

Speed with 500g bunches	up to 60 pieces / min (with an average asparagus weight of 60 g)
Weight bunch	max. 1 kg / tray
Tolerance weight	+/- 1 g
Number of removal trays	8
Return belt for overrun	10.1 m
Width	1.9 m
Length	12.1 m
Height	2.0 m
Weight	3.200 kg



### Highly precise weighing with minimal tolerance!

ASPAWAAG E heralds a new era in asparagus weighing. It combines the turbocharger, a cutting unit and the exact weight registration to make the most intelligent weighing unit on the market.



Video

## This is how to bundle asparagus

By using the **Aspapak asparagus bundling machine**, your bunches are tied in an instant – in your choice of sizes.

### Flexible, faster packing

You save valuable time and minimize costs.

The asparagus is transported safely and without a binding stop by means of three toothed belts and holders. Two binders tie the asparagus ensure with elastic yarn into suitable bunches. Integrated exit conveyor belts deposit the asparagus bunches on the downstream round table.



### TECHNICAL DATA

Base body	Stainless steel 1.4301
Speed	up to 70 strokes / min.
Number of binders	2
Binding material	Elastic yarn
Applications	Asparagus, vegetables, flowers, herbs, non-food articles
Release switch	Lichtschranke
Width	0.9 m
Height	0.9 m
Length	Variable, depending on size: 4.5 – 16.5 m (without round table)

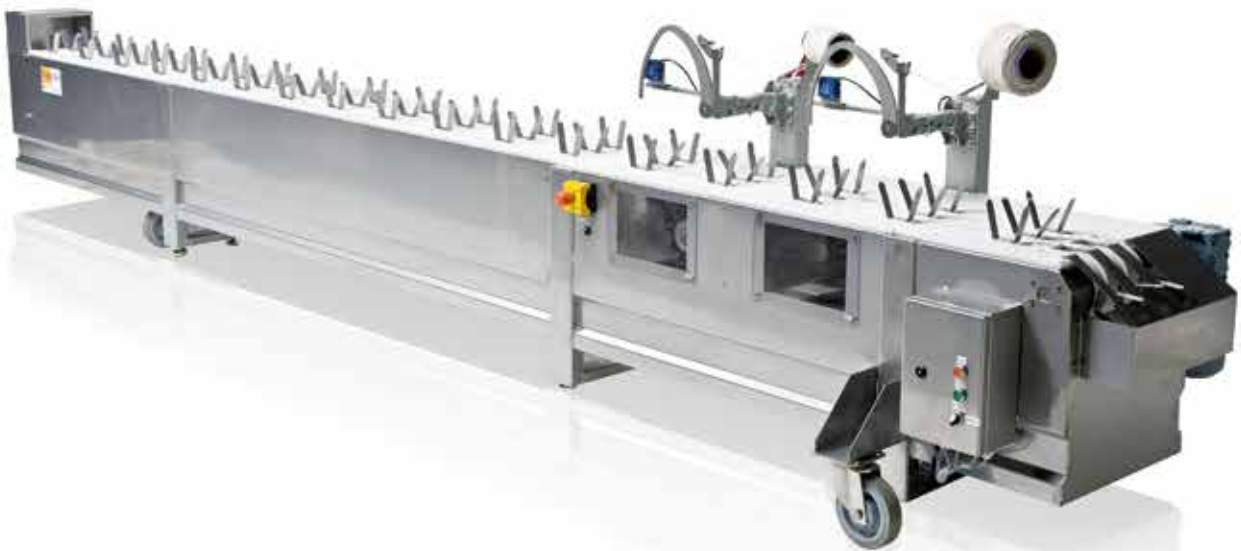

With us you can buy yarn in different colors and qualities.





# Compact - efficient - accurate

The compact ASVA 60 and the ASVA 120 pre-washing units are ideal for thorough pre-washing of your asparagus. The asparagus is cleaned from above and below in a single sequence, which saves time and costs. The ASVA is available in two variants and sizes.

The compact, powered ASVA 60 is the low-cost alternative for small companies. The ASVA 120 with two powerful 60 m<sup>3</sup>/h pumps and drive unit is the optimal solution for the fastest possible pre-washing of even larger amount of asparagus.



## ASVA 60

60 m<sup>3</sup>/h water through-flow with a waste water pump

Cleaning of the asparagus from above and below by means of a series of nozzles

Transporting of the asparagus boxes in the washing section by means of a V-belt drive

Forward feed via Vario transmission, adjustable from 0.4 - 2.4 m/min.

As standard, feeding and transporting of the asparagus boxes takes place via the conveyor belts' downward angle.

Blue plastic rollers, [Ø 50 mm], with stainless steel balls  
Roller distance 100 mm

Roller conveyor width 520 mm with side box guide

Height-adjustable by means of levelling feet to compensate for floor unevenness

Tank capacity 740 liters

## ASVA 120

120 m<sup>3</sup>/h water through-flow with two waste water pumps

Cleaning of the asparagus from above and below by means of a series of 2 nozzles each

Transporting of the asparagus boxes in the washing section by means of a V-belt drive

Forward feed via Vario transmission, adjustable from 0.4 - 2.4 m/min.

As standard, feeding and transporting of the asparagus boxes takes place via the conveyor belts' downward angle.

Blue plastic rollers, [Ø 50 mm], with stainless steel balls  
Roller distance 100 mm

Roller conveyor width 520 mm with side box guide

Height-adjustable by means of levelling feet to compensate for floor unevenness

Larger water container for cleaning water and floor deposits, easy emptying and cleaning.

Tank capacity 1100 liters

## Optimize Packing performance!

Many foodstuff discounters specify a length of 22 cm for white asparagus in their product range, although a new EU standard revokes this. This means a division of the market into asparagus lengths of up to and more than 22 cm.

The producers take this into account by cutting, washing and sorting the length of the raw product up to 24 cm. In a second step, the sorted goods are shortened and packed to meet the order.

Neubauer Automation's AspaCut optimizes the shortening process. It cuts pre-sorted asparagus spears at up to 10.80 m/min and considerably increases the packing performance.

A wide range of accessories, like roller conveyors, roller conveyor curves, conveyor belts, work tables and scales from our product range ensure even more efficient flow of goods.



### TECHNICAL DATA

Overall length	9.00 m
Length of loading section	3.50 m
Length of removal section	4.50 m
Oil-free toothed-belt technology takes care of transporting the asparagus	
Our tried-and-tested cutting technology with a higher rotating blade speed creates an exact,	
Integrated cut-off conveyor (optional)	
Continuously variable speed from 5.50 - 10.80 m/min.	



## ROLLER CONVEYORS - LOGISTICS FOR ASPARAGUS AND STRAWBERRIES

Roller conveyors optimize the flow of goods, saving time, cost and space. As a link in the production process, as part of warehouse logistics, or in the dispatch department: You can easily move heavy loads with minimal space requirement. The integrated scales and the flexible, easy-to-handle roller conveyors provide a logistical all-round solution. In addition, Neubauer Automation roller conveyors are maintenance-free and comply with foodstuffs legislation



### STAINLESS STEEL ROLLER CONVEYOR

Stainless steel [1.4301] base body, height-adjustable  
Levelling feet to compensate for floor unevenness  
Blue plastic rollers, Ø 50 mm, grey Ø 30 mm  
Roller distance 100 mm, or 35 mm for strawberry trays  
Plastic inserts with non-rusting ball bearings  
Side box guide 420 mm, 520 mm, 620 mm  
Separation 2 m, alternatively 1 m



### ROLLER CONVEYOR SCALES

Up to 60 kg (calibratable), resolution 20 g  
Stainless steel [1.4301] base body, length 2 m or longer  
Height-adjustable  
Blue plastic rollers, Ø 50 mm  
Roller distance 100 mm  
Plastic inserts with non-rusting ball bearings  
Side box guide 520 mm



### ROLLER CONVEYOR CURVE 90°

Stainless steel [1.4301] base body  
Blue plastic rollers, Ø 50 mm, three-piece  
Plastic inserts with non-rusting ball bearings  
Side box guide 420 mm, 520 mm, 620 mm



### DUAL ROLLER CONVEYOR

Technical details see stainless steel roller conveyor  
Illustration shows an example of assembly for two levels: Lower level for empty containers, upper level for finished goods

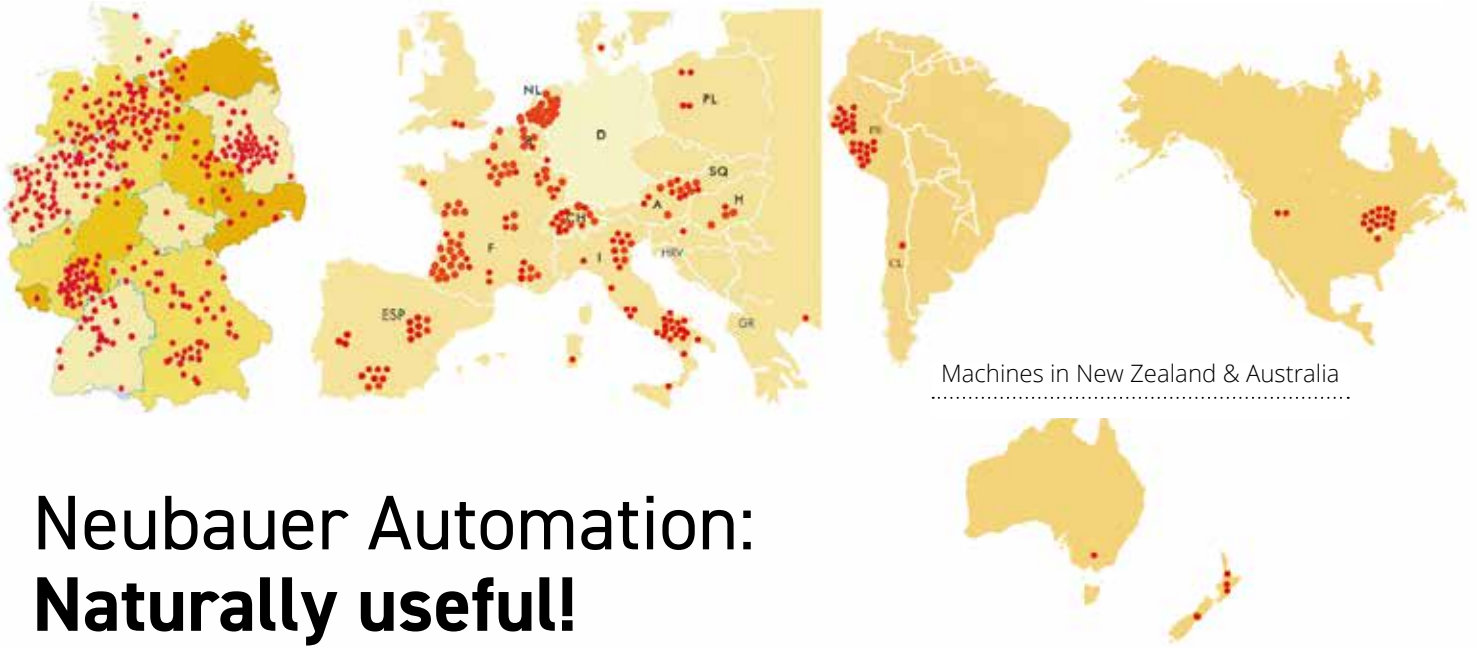

## Neubauer Automation: Naturally useful!

With the increasing optimization of modern production processes, the need for specific problem solutions grows. Individual machines with progressive technology reduce the costs for your company.

### **Our goal is clearly defined: To increase your productivity!**

The Neubauer Automation team in Westphalian Welver has been manufacturing intelligent, computer-aided machines for agriculture, the automotive industry and mechanical engineering since 1982.

For us, precision and speed are not just empty words, but necessary requirements, both for our systems and for ourselves. The Neubauer Automation team leaves nothing to chance when it comes to product development.

That is why we manufacture almost all individual parts in-house. In this way, we can guarantee the consistently high quality of our products and we can always supply spare parts, no matter how old your machine is.

Neubauer Automation has been developing the asparagus sorting machine ESPASO since 1999 and has been writing a success story since then.

In a few years Neubauer Automation moved forward to the world undisputed Market leader for asparagus sorting machines. The sorting machines of the ESPASO family are impressive due to their compact dimensions, most modern sorting software, short operating paths, impressive sorting quality and speed. Characteristics, that our national and international customers appreciate.



Neubauer Automation OHG  
Gewerbegebiet Scheidingen  
Am Bierbäumchen 12

D-59514 Welver

phone +49 / 23 84 / 9 20 22-0

fax +49 / 23 84 / 9 20 22-99

[www.neubauer-automation.de](http://www.neubauer-automation.de)

[www.espaso.com](http://www.espaso.com)

[info@espaso.de](mailto:info@espaso.de)



**Neubauer**  
Automation